

Firewalls

Security threats and network

- As we have already discussed, many serious security threats come from the networks;
- The firewalls implement hardware or software solutions based on the control of network connections between local network and other networks.

Hardware firewall

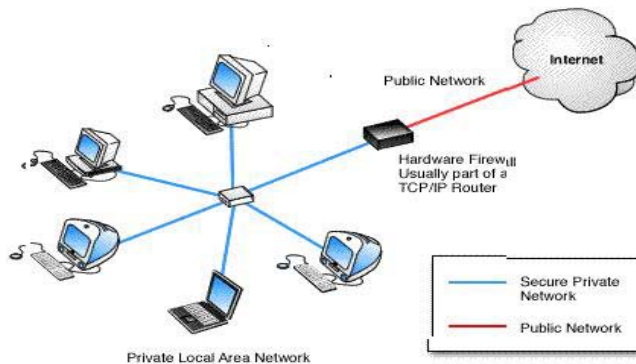

Software firewall

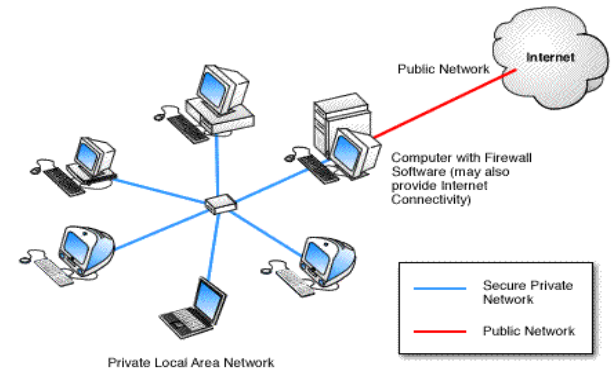

Layers in network connections (OSI model)

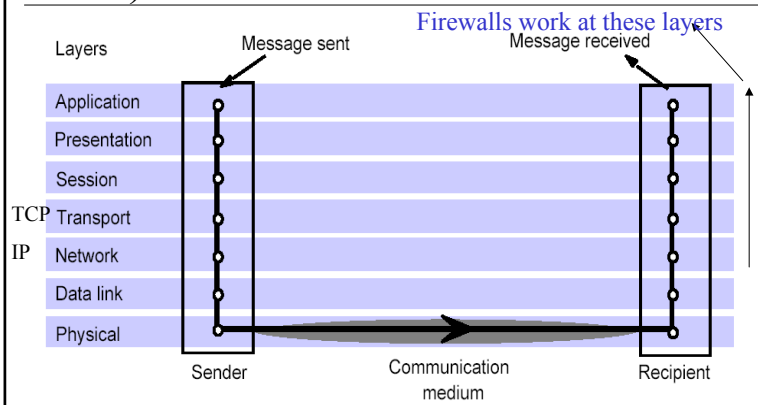

COMP 522

Messages in OSI model

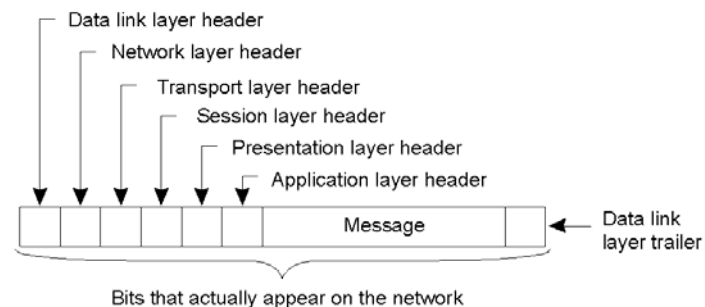

COMP 522

Firewall characteristics

- All traffic from inside to outside, and vice versa, must pass through the firewall. All access to the local network is blocked except via firewall.
- Only authorized traffic, defined by the local security policy is allowed to pass in either direction.
- The firewall itself can not be penetrated.

COMP 522

Types of control used by firewalls

- **Service control:** determines what types of services can be accessed;
- **Direction control:** determines in which direction particular service request may be initiated;
- **User control:** determines access to a service according to a user;
- **Behaviour control:** controls how particular services are used.

COMP 522

Limitations of the firewalls

- Cannot protect against attacks that bypass the firewall.
- Does not protect against internal threats.
- Cannot protect, in general, against transfer of virus-infected programs or files.

Types of firewalls

- **Packet filtering router** (works at the network layer, IP)
- **Circuit-level gateway** (works at the transport layer, TCP)
- **Application-level gateway** (works at higher layers)

Packet-filtering router

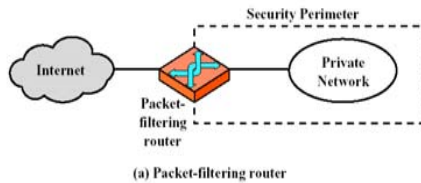

- A packet-filtering router applies a set of rules to each incoming IP packet and then forwards or discards the packet.
- Filtering is based on information contained in a network packet

Filtering rules

Filtering rules are based on

- **Source IP address**
- **Destination IP address**
- **Source and Destination transport-level address:** transport level port number
- **IP protocol field:** defines the transport protocol

Default policies

One may apply rules following two different default policies:

- **Discard:** that which is not explicitly permitted is prohibited.
 - more conservative. At the beginning everything is forbidden. Then permitting rules must be added on a case-by-case basis.
- **Forward:** that which is not explicitly prohibited is permitted
 - More convenient to use, but less secure. Once security threat is recognized, specific forbidding rule(s) must be added

Packet-filtering examples (Default=discard)

	action	ourhost	port	theirhost	port	comment
A	block	*	*	SPIGOT	*	we don't trust these people
	allow	OUR-GW	25	*	*	connection to our SMTP port

	action	ourhost	port	theirhost	port	comment
B	block	*	*	*	*	default

	action	ourhost	port	theirhost	port	comment
C	allow	*	*	*	25	connection to their SMTP port

	action	src	port	dest	port	flags	comment
D	allow	{our hosts}	*	*	25		our packets to their SMTP port
	allow	*	25	*	*	ACK	their replies

	action	src	port	dest	port	flags	comment
E	allow	{our hosts}	*	*	*		our outgoing calls
	allow	*	*	*	*	ACK	replies to our calls
	allow	*	*	*	>1024		traffic to nonservers

Pros and cons of packet filtering

Pros:

- Simple;
- Transparent for users;
- Very fast.

Cons:

- Lack of upper-layer functionality;
- Do not support advanced user authentication schemes;
- Cannot block specific application commands: either the application is disallowed, or all its functions are permitted;

Circuit-level gateway

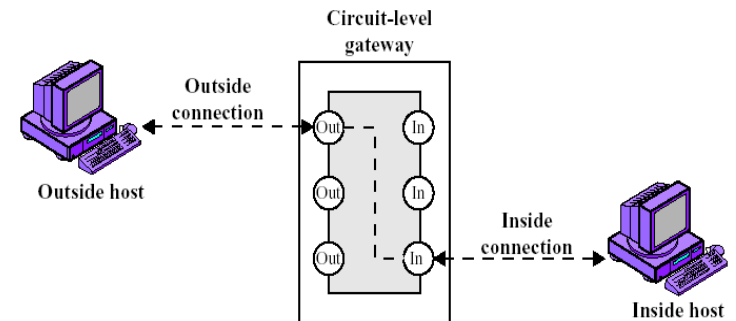

(c) Circuit-level gateway

Circuit-level gateways

- Traffic is filtered based on specified *session* rules, like:
 - a session is initiated by a recognized computer;
- A circuit-level gateway sets up two connections:
 - One between itself and a TCP user on the inner host;
 - One between itself and a TCP user on the outer host;
- Once connections are established and security criteria are met, both connections are linked by the gateway;

Pros and cons of circuit-level gateways

Pros:

- Circuit-level gateways are relatively inexpensive;
- have the advantage of hiding information about the private network they protect.

Cons:

- do not filter individual packets.

Application-level gateway

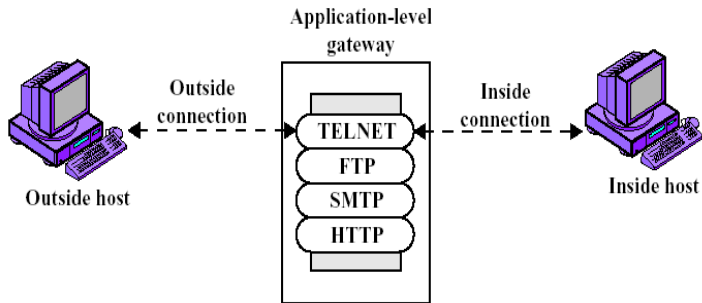

(b) Application-level gateway

Application layer gateways (proxies)

- They can filter packets at the application layer of the OSI model.
- Incoming or outgoing packets cannot access services for which there is no proxy:
 - for example, an application level gateway that is configured to be a web proxy will not allow any ftp, telnet or other traffic through.
- They can filter application specific commands such as http:post and get, etc.

Pros and Cons of Application-Level Gateways

- **Pros:**
 - They offer a high level of security;
 - Application specific protection;
- **Cons**
 - significant impact on network performance;
 - are not transparent to end users; and
 - require manual configuration of each client computer.

Firewalls: benefits and problems

Benefits:

- firewalls protect private local area networks from hostile intrusion from the Internet;
- flexibility in implementation of security policies;
- relatively inexpensive solution.

Possible problems:

- Possible traffic bottleneck;
- Security concentrated in one spot;